



**ISOMECC**  
SANDWICH PANELS



AGRI DOMUS



Standard				A richiesta On demand				
----------	---	---	---	--------------------------	---	---	---	---



Pannello ideale per il contesto agricolo e rurale. Valida alternativa alle coperture in cotto laterizio, soddisfacendo le esigenze del comparto agro-zootecnico.

Come elemento di coperture con pendenze  $\geq 16\%$  viene applicato su tetti a struttura continua. Supporto esterno con sagoma del classico cotto, per un aspetto tradizionale. Supporto interno in vetroresina, facilmente igienizzabile e resistente agli agenti chimici del settore (può subire alterazioni cromatiche).

L'utilizzo corretto è previsto con il supporto rigido in lamiera rivolto verso l'alto, su sottostruttura continua (tavolato piano, solaio in calcestruzzo).

The ideal panel for rural and agricultural contexts. An excellent alternative to traditional roofing in masonry tiles, meeting all the needs of the farming sector.

It can be used as a roofing element with a slope of  $\geq 16\%$ , applied to continuous roof structures. The outer surface with its classic tiled contours gives it a traditional look. The inner surface in fibreglass-reinforced plastic makes it easy to clean and resistant to the chemical agents used in this sector (it may undergo some colour changes).

It must be laid with the rigid sheet metal surface facing upward on a continuous sub-structure (flat planing, concrete flooring).

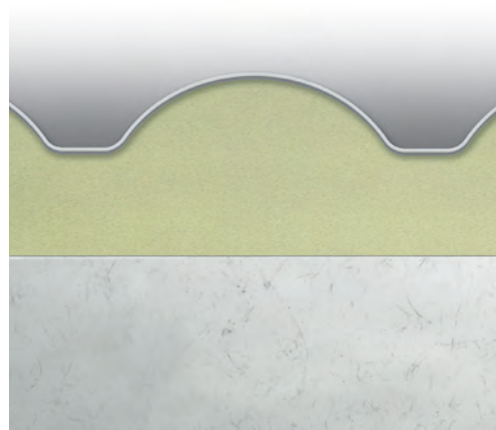
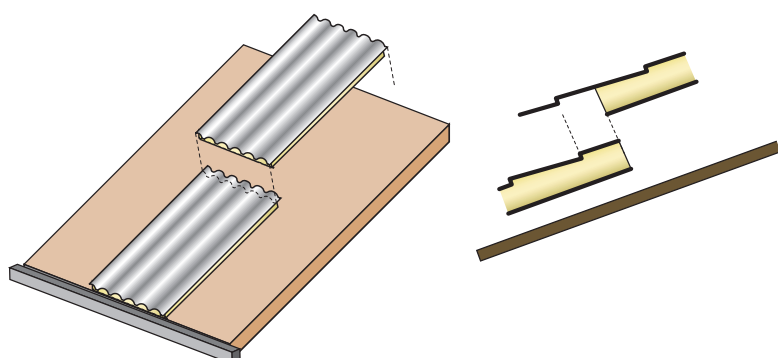

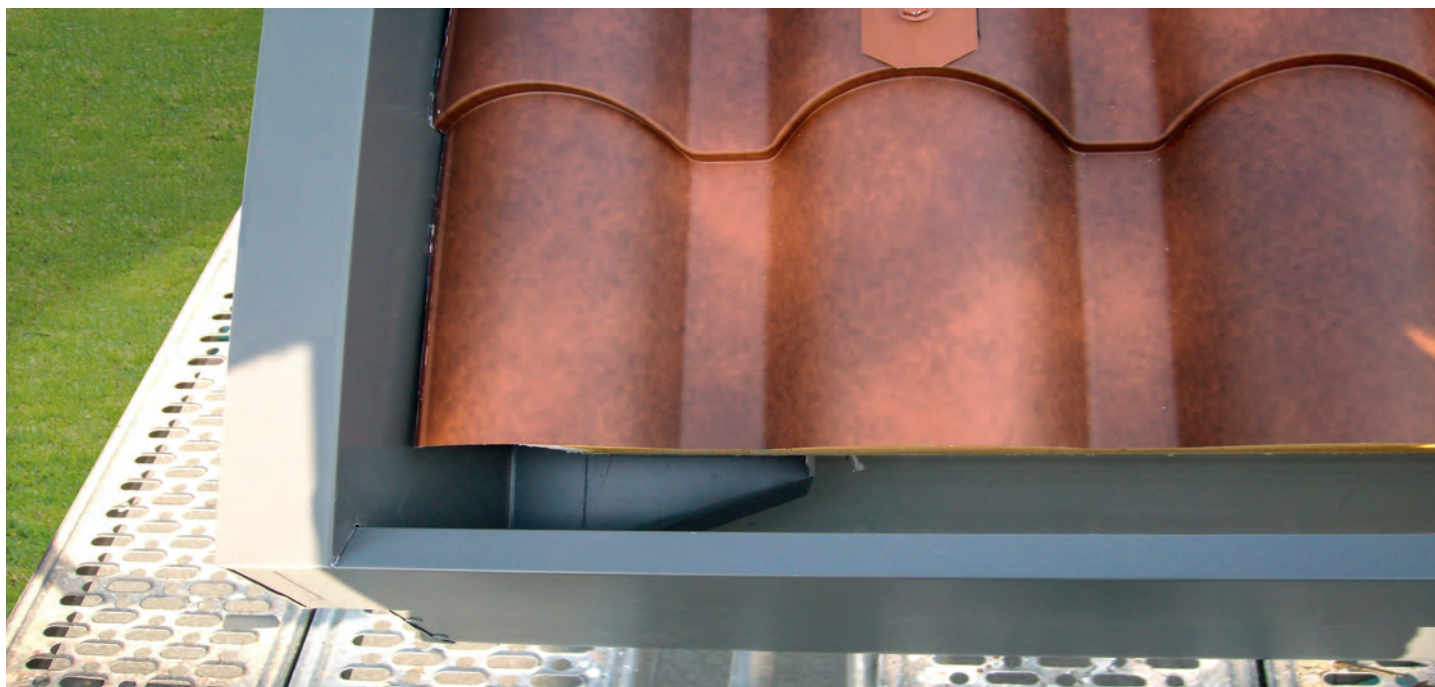

Micronervature

Profile types

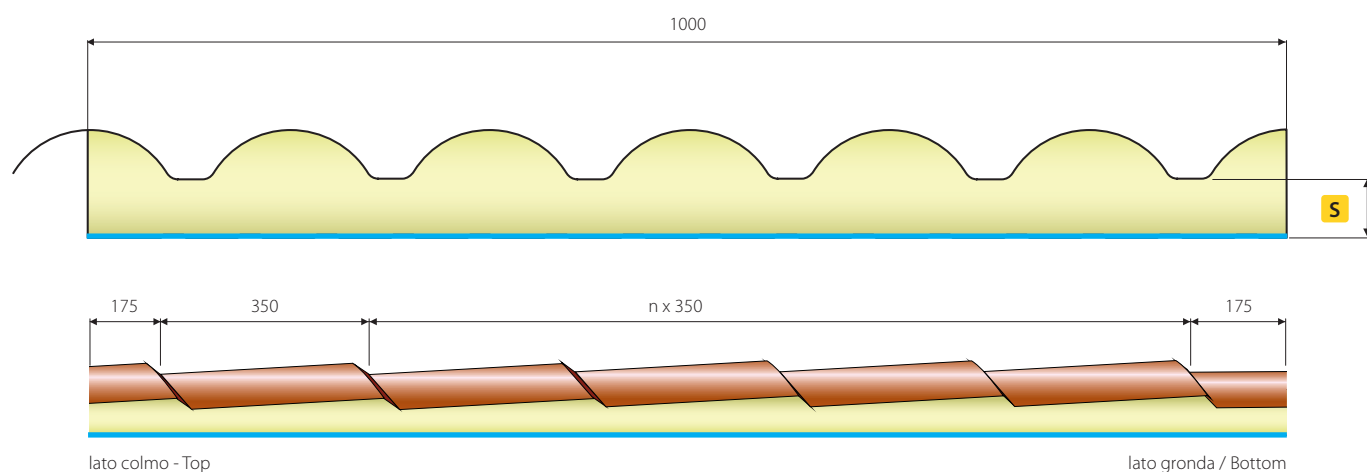

AGRI DOMUS	Standard	A richiesta – On demand
Finiture esterne - External finishin	Coppo - Tile	Guarnizione - Gasket
Finiture interne - Internal finishin	Vetroresina stabilizzata UV Fibre glass UV Stabilized	---
Superfici es erne External surface	Acciaio-Steel EN10346/Inox EN10088 Alluminio-Aluminium EN485	Granite-Color Farm/Plastisol/Aluzinc HDX/Z150-275 - PET - PVDF - PVC
Isolanti - Insulating	PUR	B1-B2 / PUR2-PUR3 / PIR-POLYISO-IPN

**Proprietà meccaniche Acciaio EN14509 - Mechanical Properties: Steel EN 14509**

S (mm)	Peso Weight (kg/m <sup>2</sup> )	K (W/m <sup>2</sup> K)	Vetroresina stabilizzata UV. Peso ca 1000 g/m <sup>2</sup> con fibra di vetro al 25-27% sul peso del laminato. Temperatura d'impiego compresa tra -40/+120 °C. Resistenza agenti chimici: acidi/ottima; alcoli/ottima; alcali/buona; solventi/buona. Per informazioni più dettagliate è necessario conoscere la natura e la concentrazione dell'agente chimico e le condizioni ambientali di utilizzo. Spessore 0,5 mm. Colore bianco opalino	Fibre glass UV Stabilized. Approximate weight 1000 g/m <sup>2</sup> with fi bre glass 25-27% on overall rolled sheet weight. Operating temperature comprised between -40/+120 °C. Chemical resistance: acids/optimal; alcohol/optimal; alkali/good; solvents/good. For more detailed information it is necessary to know the nature and concentration of the chemical agent as well as environmental usage conditions. Thickness 0.5mm. Frosted white colour.
40	8,00	0,38		
50	8,40	0,33		
60	8,80	0,28		
80	9,50	0,22		



## **Contacts**

### **Contatti**

#### **Finance - Management**

##### **Amministrazione**

Viale del lavoro 19, Z.I. Paludi

Alpago (BL)

Ph. +39 0437 989105

Fax +39 0437 989198

[www.isomec.it](http://www.isomec.it)

#### **Sales - Logistics**

##### **Uffici - commerciali - Logistica**

Viale del lavoro 19, Z.I. Paludi

Alpago (BL)

Ph. +39 0437 989105

Fax +39 0437 989198

[www.isomec.it](http://www.isomec.it)

#### **Production and registered office**

##### **Produzione e sede legale**

Viale del lavoro 31, Z.I. Paludi

Alpago (BL)

Ph. +39 0437 989206

Fax +39 0437 982084

[www.isomec.it](http://www.isomec.it)

#### **Mail:**

Information - Informazioni:

[isomec@isomec.it](mailto:isomec@isomec.it)

Finance - Amministrazione:

[amministrazione@isomec.it](mailto:amministrazione@isomec.it)

Accounting - Contabilità:

[contabile@isomec.it](mailto:contabile@isomec.it)

Sales - Vendite:

[commerciale@isomec.it](mailto:commerciale@isomec.it)

Logistics - Logistica:

[spedizioni@isomec.it](mailto:spedizioni@isomec.it)

Production - Produzione:

[produzione@isomec.it](mailto:produzione@isomec.it)