





ISOMEK

SANDWICH PANELS





Standard	 	A richiesta all'ordine At request at the order	  
----------	---	---	---

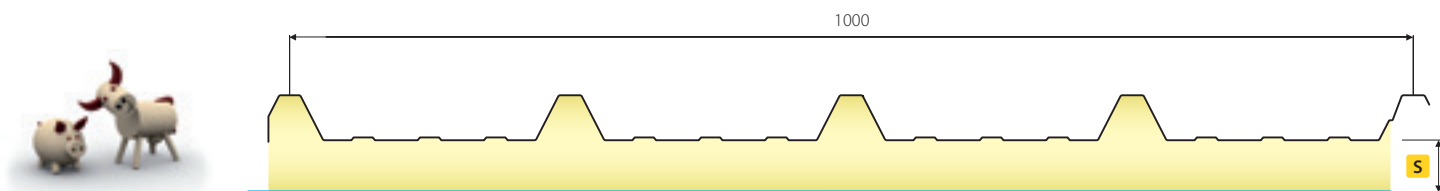

Isomec ha messo a punto un particolare pannello sandwich per le coperture del settore agricolo: allevamenti di polli e tacchini, stalle per bovini, scuderie o porcili hanno infatti esigenze differenti in termini di prestazione, colore e non ultimo durata. Il nostro staff tecnico ha esaminato queste differenze per creare un prodotto resistente agli agenti chimici di origine animale. Il vostro bestiame vivrà in business class.

Pendenza minima del 7%. Giunto incastro maschio/femmina. Il fissaggio è di tipo passante con possibilità utilizzo di cappellotti. Si consiglia di eseguire sempre la sigillatura.

Isomec has created a very special sandwich panel for the roofing in such farming sectors as poultry rearing units, cattle stalls, stables and pig units all of which have different needs in terms of performance, colour and, naturally, longevity. Our expert technical team has studied these differences and created a product with high resistance to chemical agents of animal origin. Your livestock will enjoy 5-star accommodation.

Minimum slope of 7%. Male/female joints. The fixing is feed-through and cap nuts can be used. We recommend always using sealant.

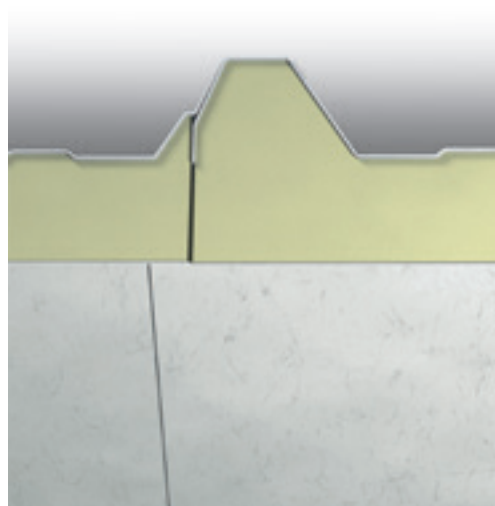
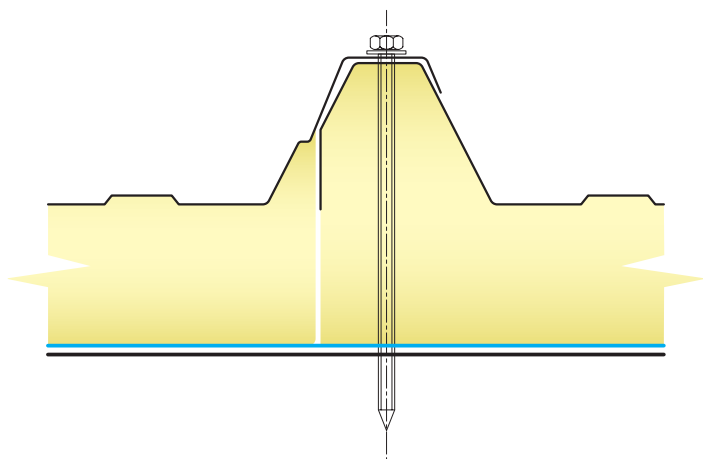



Micronervature

Profile types



ISOAGRI	Standard	A richiesta – On demand
Finiture esterne - External finishing	5G	-
Finiture interne - Internal finishing	Vetroresina stabilizzata UV. Peso ca 1000 g/m ² con fibra di vetro al 25-27% sul peso del laminato. Temperatura d'impiego compresa tra -40/+120 °C. Resistenza agenti chimici: acidi/ottima; alcoli/ottima; alcali/buona; solventi/buona. Per informazioni più dettagliate è necessario conoscere la natura e la concentrazione dell'agente chimico e le condizioni ambientali di utilizzo. Spessore 0,5 mm. Colore bianco opalino.	Fibre glass UV Stabilized. Approximate weight 1000 g/ m ² with fibre glass 25-27% on overall rolled sheet weight. Operating temperature comprised between -40/+120 °C. Chemical resistance: acids/optimal; alcohol/optimal; alkali/good; solvents/good. For more detailed information it is necessary to know the nature and concentration of the chemical agent as well as environmental usage conditions. Thickness 0.5mm. Frosted white colour.
Superfici esterne External surface	Acciaio-Steel EN10346/Inox EN10088 Alluminio-Aluminium EN485	Granite-Color Farm/Plastisol/Aluzinc HDX/Z150-275 - PET - PVDF - PVC
Isolanti - Insulating	PUR3	PUR2 - PIR - POLYISO - IPN

Proprietà meccaniche Acciaio - Mechanical Properties: Steel

S (mm)	Peso Weight (kg/m ²)	K (W/m ² K)	Sp. (mm)	L (m)	L					L				
					1,00	1,50	2,00	2,50	3,00	1,00	1,50	2,00	2,50	3,00
40	7,40	0,55	0,5	Portata Max Load P=kg/m ²	460	200	115			560	240	130	80	
50	7,80	0,44	0,6		560	245	130	70		680	300	165	100	65
60	8,20	0,37	0,7		660	290	150	80		850	375	200	130	80
80	9,00	0,28	0,8		760	340	180	90	55	1000	445	245	150	100
100	9,80	0,22												



Contacts

Contatti

Finance - Management

Amministrazione

Viale del lavoro 19, Z.I. Paludi

32016 Alpago (BL)

Ph. +39 0437 989105

Fax +39 0437 989198

www.isomec.it

Sales - Logistics

Uffici - Commerciali - Logistica

Viale del lavoro 19, Z.I. Paludi

32016 Alpago (BL)

Ph. +39 0437 989105

Fax +39 0437 989198

www.isomec.it

Production and registered office

Produzione e sede legale

Viale del lavoro 31, Z.I. Paludi

32016 Alpago (BL)

Ph. +39 0437 989206

Fax +39 0437 982084

www.isomec.it

Mail:

Information - Informazioni:

isomec@isomec.it

Finance - Amministrazione:

amministrazione@isomec.it

Accounting - Contabilità:

contabile@isomec.it

Sales - Vendite:

commerciale@isomec.it

Logistics - Logistica:

spedizioni@isomec.it

Production - Produzione:

produzione@isomec.it